

DISS Fittings

Diameter Index Safety System

The Compressed Gas Association (CGA) developed the Diameter-Index Safety system (DISS) to establish a standard for non-interchangeable, removable connections for use with Medical Gases, Instrument Air, Vacuum (Suction), and WAGD (Waste Anesthetic Gas Disposal). Non-interchangeable indexing is achieved by a series of increasing and decreasing diameters in the components of the connections. These specific diameters act in key-like fashion, so that fittings within the gas service "family" will connect only with their own "family members." In place of diameter indexing, Oxygen (DISS 1240) has been assigned the long established 9/16"-18 thread connections as its safety standards.

What makes our DISS fittings unique?

Medical Testing Solutions takes great care to design, engineer and manufacture these fittings to exacting tolerances. Then our fittings receive our special three-step plating process. The results produce a superior quality DISS fitting, one that you would be proud to install at your hospital or on your medical equipment. Look below to find a sampling of our DISS product line as well as details on the Diameter-Index Safety System (DISS).

DISS Nuts

200 psi max

Hex Nut

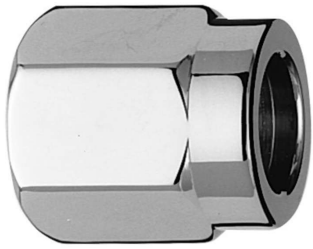

AV CORPORATION

3/4"-16 Thread

Carbon Dioxide, DISS 1080-A	1084A
He-O2 mixture (I), DISS 1060-A	1064A
Medical Air, DISS 1160-A	1164A
Nitrogen, DISS 1120-A	1124A
Nitrous Oxide, DISS 1040-A	1044A
O2-He mixture (II), DISS 1180-A	1184A
Vacuum (Suction), DISS 1220	1224





7/8"-14 Thread

Instrument Air (III), DISS 2080	2084
WAGD (EVAC), DISS 2220	2224

Hand-Tight Nut





3/4"-16 Thread

Carbon Dioxide, DISS 1080-A	 Grey	1084AHT
Medical Air, DISS 1160-A	 Yellow	1164AHT
Nitrogen, DISS 1120-A	 Black	1124AHT
Nitrous Oxide, DISS 1040-A	 Blue	1044AHT
Vacuum (Suction), DISS 1220	 White	1224HT

7/8"-14 Thread

WAGD (EVAC), DISS 2220	 Purple	2224HT
------------------------	---	---------------

ISO Color-Coded

Medical Air, DISS 1160-A	 Black & White	1164AHTC
Vacuum (Suction), DISS 1220	 Yellow	1224HTC

Cap & Chain Assembly



3/4"-16 Thread

Carbon Dioxide	1000CP
He-O2 mixture (I)	1000CP
Medical Air	1000CP
Nitrogen	1000CP
Nitrous Oxide	1000CP
O2-He Mixture (II)	1000CP
Vacuum (Suction)	1000CP

7/8"-14 Thread

Instrument Air	2000CP
WAGD (EVAC)	2000CP

DISS Body Adaptors

200 psi max ? Gas service stamped on body adaptors

Body Adaptor, 1/8" NPT Male

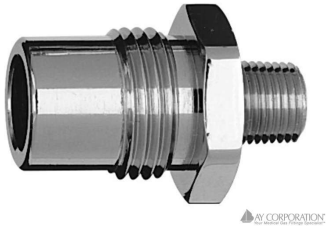

3/4"-16 Thread

Carbon Dioxide, DISS 1080-A	1081-2
He-O2 Mixture, DISS 1060-A	1061-2
Medical Air, DISS 1160-A	1161-2
Nitrogen, DISS 1120-A	1121-2
Nitrous Oxide, DISS 1040-A	1041-2
O2-He Mixture (II), DISS 1180-A	1181-2
Vacuum (Suction), DISS 1220	1221-2

7/8"-14 Thread

Instrument Air (III), DISS 2080	2081-2
WAGD (EVAC), DISS 2220	2221-2

Body Adaptor, 1/4" NPT Male



3/4"-16 Thread

Carbon Dioxide, DISS 1080-A	1081-4
He-O2 Mixture (I), DISS 1060-A	1061-4
Medical Air, DISS 1160-A	1161-4
Nitrogen, DISS 1120-A	1121-4
Nitrous Oxide, DISS 1040-A	1041-4
O2-He mixture (II), DISS 1180-A	1181-4
Vacuum (Suction), DISS 1220	1221-4

7/8"-14 Thread

Instrument Air (III), DISS 2080	2081-4
WAGD (EVAC), DISS 2220	2221-4

Body Adaptor, 1/8" NPT Female

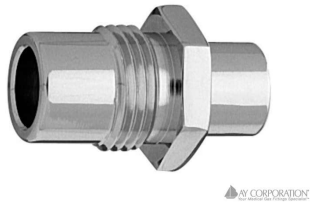

3/4"-16 Thread

Medical Air, DISS 1160-A	1161-2F
Nitrogen, DISS 1120-A	1121-2F
Nitrous Oxide, DISS 1040-A	1041-2F
Vacuum (Suction), DISS 1220	1221-2F

Body Adaptor, Barbed for 1/4" I.D. Hose

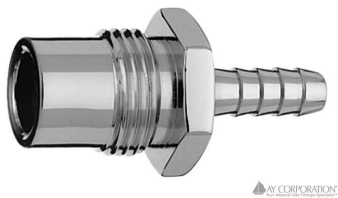





3/4"-16 Thread

Medical Air, DISS 1160-A	1161-17
He-O2 mixture (I), DISS 1060-A	1061-17
O2-He mixture (II), DISS 1180-A	1181-17



Body Adaptor, Hose Barb with Hand Grip Collar



3/4"-16 Thread

Carbon Dioxide, DISS 1080-A	 Grey	1017-31HT
Medical Air, DISS 1160-A	 Yellow	1161-17HT
Nitrogen, DISS 1120-A	 Black	1121-17HT
Nitrous Oxide, DISS 1040-A	 Blue	1041-17HT
Vacuum (Suction), DISS 1220	 White	1221-17HT

7/8"-14 Thread

WAGD (EVAC), DISS 2220	 Purple	2221-17HT
Instrument Air, DISS 2080	 Red	2081-17HT
WAGD (EVAC), DISS 2220	 Purple	2221-31HT

5/16" I.D. Hose Barb

Vacuum (Suction), DISS 1220	 White	1221-31HT
-----------------------------	--	------------------

DISS Nipples

200 psi max

Nipple, 1/8" NPT Male



Carbon Dioxide, DISS 1080-A	1083-2
He-O2 Mixture, DISS 1060-A	1063-2
Instrument Air (III), DISS 2080	2083-2
Medical Air, DISS 1160-A	1163-2
Nitrogen, DISS 1120-A	1123-2
Nitrous Oxide, DISS 1040-A	1043-2
O2-He Mixture (II), DISS 1180-A	1183-2
Vacuum (Suction), DISS 1220	1223-2
WAGD (EVAC), DISS 2220	2223-2

Nipple, 1/4" NPT Male



Carbon Dioxide, DISS 1080-A	1083-4
Instrument Air (III), DISS 2080	2083-4
Medical Air, DISS 1160-A	1163-4
Nitrogen, DISS 1120-A	1123-4
Nitrous Oxide, DISS 1040-A	1043-4
Vacuum (Suction), DISS 1220	1223-4
WAGD (EVAC), DISS 2220	2223-4

Nipple, Barbed for 1/4" I.D. Hose



Carbon Dioxide, DISS 1080-A	1083-17
He-O2 Mixture, DISS 1060-A	1063-17
Instrument Air (III), DISS 2080	2083-17
Medical Air, DISS 1160-A	1163-17
Nitrogen, DISS 1120-A	1123-17
Nitrous Oxide, DISS 1040-A	1043-17
O2-He Mixture (II), DISS 1180-A	1183-17
Vacuum (Suction), DISS 1220	1223-17
WAGD (EVAC), DISS 2220	2223-17

Nipple, Barbed for 5/16" I.D. Hose

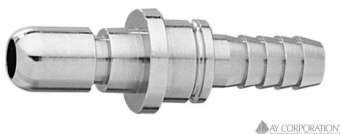

Vacuum (Suction), DISS 1220	1223-31
WAGD (EVAC), DISS 2220	2223-31

Retaining Ring

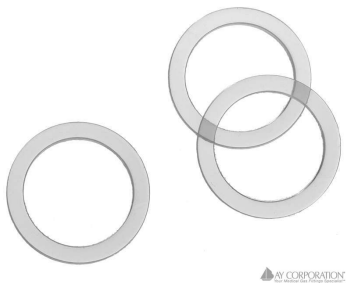

Carbon Dioxide, DISS 1080-A	RR-1
He-O2 Mixture, DISS 1060-A	RR-1
Instrument Air (III), DISS 2080	RR-3
Medical Air, DISS 1160-A	RR-1
Nitrogen, DISS 1120-A	RR-1
Nitrous Oxide, DISS 1040-A	RR-1
O2-He Mixture (II), DISS 1180-A	RR-1
Vacuum (Suction), DISS 1220	RR-1
WAGD (EVAC), DISS 2220	RR-3

DISS Nipples with O-rings

200 psi max

Nipple with O-Ring, 1/8" NPT Male



Carbon Dioxide, DISS 1080-A	1083-20
He-O2 Mixture, DISS 1060-A	1063-20
Instrument Air (III), DISS 2080	2083-20
Medical Air, DISS 1160-A	1163-20
Nitrogen, DISS 1120-A	1123-20
Nitrous Oxide, DISS 1040-A	1043-20
O2-He Mixture (II), DISS 1180-A	1183-20
Vacuum (Suction), DISS 1220	1223-20
WAGD (EVAC), DISS 2220	2223-20

Nipple with O-Ring, 1/4" NPT Male



Carbon Dioxide, DISS 1080-A	1083-40
Instrument Air (III), DISS 2080	2083-40
Medical Air, DISS 1160-A	1163-40
Nitrogen, DISS 1120-A	1123-40
Nitrous Oxide, DISS 1040-A	1043-40
Vacuum (Suction), DISS 1220	1223-40
WAGD (EVAC), DISS 2220	2223-40

Nipple with O-Ring, Barbed for 1/4" I.D. Hose



Carbon Dioxide, DISS 1080-A	1083-170
He-O2 Mixture, DISS 1060-A	1063-170
Instrument Air (III), DISS 2080	2083-170
Medical Air, DISS 1160-A	1163-170
Nitrogen, DISS 1120-A	1123-170
Nitrous Oxide, DISS 1040-A	1043-170
O2-He Mixture (II), DISS 1180-A	1183-170
Vacuum (Suction), DISS 1220	1223-170
WAGD (EVAC), DISS 2220	2223-170

Nipple with O-Ring, Barbed for 5/16" I.D. Hose



Vacuum (Suction), DISS 1220	1223-310
WAGD (EVAC), DISS 2220	2223-310

O-Ring Replacement



Carbon Dioxide, DISS 1080-A	1080-0
He-O2 Mixture, DISS 1060-A	1060-0
Instrument Air (III), DISS 2080	2080-0
Medical Air, DISS 1160-A	1160-0
Nitrogen, DISS 1120-A	1120-0
Nitrous Oxide, DISS 1040-A	1040-0
O2-He Mixture (II), DISS 1180-A	1180-0
Vacuum (Suction), DISS 1220	1220-0
WAGD (EVAC), DISS 2220	2220-0

DISS 1240 Oxygen Nuts, and Components

200 psi max ? 9/16"-18 Thread

Hex Nut



AV CORPORATION

Oxygen

1244

Wing Nut



AV CORPORATION

Oxygen



1244WN

Hand-Tight Nut



AV CORPORATION

Oxygen, US



1244HT

Oxygen, ISO



1244HTW

Nipple, 1/8" Male

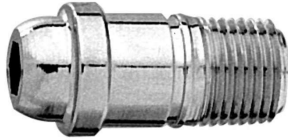

AV CORPORATION

1" Long	1243-1
1 1/2" Long	1243-2

Nipple, 1/8" NPT Male with O-Ring



AV CORPORATION

1" Long	1243-10
1 1/2" Long	1243-20

Nipple, Hose Barb



AV CORPORATION

	3/16" I.D. Hose Barb	
For 3/16" I.D. Hose		1243-18
	1/4" I.D. Hose Barb	
Without retaining ring groove		1243-17
With retaining ring groove		1242-3-1

Nipple, Hose Barb with O-Ring



AV CORPORATION

	3/16" I.D. Hose Barb	
1.44" Long		1243-180
	1/4" I.D. Hose Barb	
Without retaining ring groove		1243-170
With retaining ring groove		1242-3-10

Nipple, Tapered Barb (I)

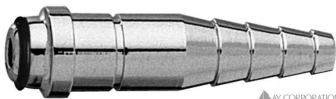

AV CORPORATION

For 1/4" - 3/8" I.D. Hose (with O-Ring)	1243-380
---	----------

Components

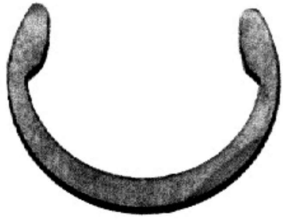

AV CORPORATION

Replacement O-Ring	1240-0
Nut Retaining Ring	SR-1

DISS 1240 Oxygen Body Adaptors

200 psi max ? 9/16"-18 Thread

Body Adaptor, NPT Male

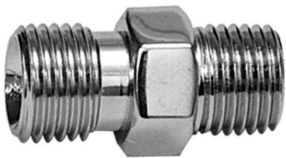

AV CORPORATION

1/8" NPT Male	1241-2
1/4" NPT Male	1241-4

Body Adaptor, NPT Female

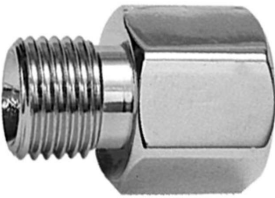

AV CORPORATION

1/8" NPT Female	1241-6
1/4" NPT Female	1241-7

Body Adaptor, Hose Barb

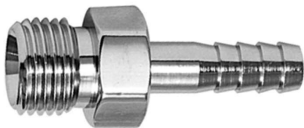

AV CORPORATION

Barbed for 1/4" I.D. Hose	1241-17
---------------------------	----------------

Body Adaptor, NPT Male with Filtered #77 Orifice (Orifice Size Stamped on Body Adaptor)

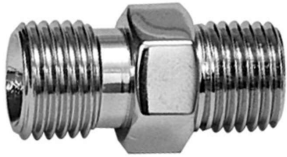

AV CORPORATION

1/8" NPT Male	1241-277
1/4" NPT Male	1241-477

Body Adaptor, Hose Barb with Hand Grip Collar



AV CORPORATION

U.S. Color Coding

1/4" Hose Barb with Hand Grip Collar	 Green	1241-17HT
--------------------------------------	--	------------------

ISO Color Coding

1/4" Hose Barb with Hand Grip Collar	 White	1241-17HTW
--------------------------------------	--	-------------------

Barbed for 1/4" I.D. Hose, Green	1241-17HT
Barbed for 1/4" I.D. Hose, White	1241-17HTW

DISS 1240 Oxygen Adaptors and Connections

200 psi max ? 9/16"-18 Thread

Cap & Chain Assembly



AV CORPORATION

Cap & Chain Assembly	1242-2
----------------------	---------------

Tapered Nipple Assembly, with hex nut and 5 in. chain (I)



Tapered Nipple Assembly, with hex nut and 5 in. chain	1244-6
---	---------------

Male Coupler

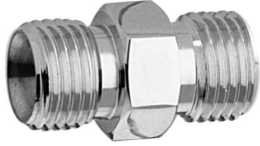

AV CORPORATION

Male Coupler

1242-5

Female Coupler

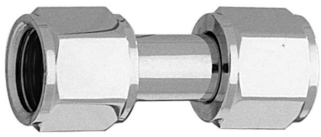

AV CORPORATION

Female Coupler

1242-11

Two-Piece Swivel Outlet, Disposable (I)



AV CORPORATION

Two-Piece Swivel Outlet, Disposable



Green

1244-3D

Two-Piece Swivel Outlet, Disposable (ISO)



White

1244-3DW

Two-Piece Swivel Outlet, Disposable



Yellow

1244-3YL

Two-Piece Swivel Outlet, Disposable



Black

1244-3BL

Tapered Nipple Assembly, with hand tight nut and 5" chain (I)



Tapered Nipple Assembly, with hand tight nut and 5" chain



Green

1244-8

Tapered Nipple Assembly, with hand tight nut and 5" chain (ISO)



White

1244-8W

DISS 1240 Oxygen Female Adaptors

200 psi max ? 9/16"-18 Thread

Straight Design with NPT Male



AV CORPORATION

DISS Female x 1/8" NPT Male 1242-6

DISS Female x 1/4" NPT Male 1242-7

Straight Design with NPT Female

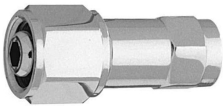

AV CORPORATION

DISS Female x 1/8" NPT Female 1242-8

DISS Female x 1/4" NPT Female 1242-9

90° Designs with DISS Male



AV CORPORATION

DISS Female x DISS Male, Nipple Length-3/4" 1249-1S

DISS Female x DISS Male, Nipple Length-1 1/2" 1249-1

DISS Female x DISS Male, Nipple Length-2" 1249-1L

90° Design with NPT Male

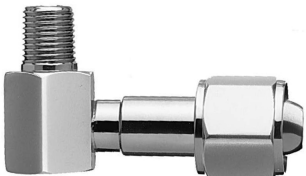

AV CORPORATION

DISS Female x 1/8" NPT Male, Nipple Length-1 1/2" 1249-2

DISS Female x 1/8" NPT Male, Nipple Length-3/4" 1249-3

DISS Hex Nut & Nipple Combinations

200 psi max ? includes O-rings (unless otherwise noted)

Hex Nut and Nipple with 1/8" NPT Male



AV CORPORATION

9/16"-18 Thread

Oxygen, DISS 1240, with 1" nipple (without O-ring)	2402
Oxygen, DISS 1240, with 1 1/2" nipple (without O-ring)	1242-6
Oxygen, DISS 1240, with 1" nipple	2402-10
Oxygen, DISS 1240, with 1 1/2" nipple	1242-60

3/4"-16 Thread

Carbon Dioxide, DISS 1080-A	0802
He-O2 Mixture (I), DISS 1060-A	0602
Medical Air, DISS 1160-A	1602
Nitrogen, DISS 1120-A	1202
Nitrous Oxide, DISS 1040-A	0402
O2-He Mixture (II), DISS 1180-A	1802
Vacuum (Suction), DISS 1220	2202

7/8"-14 Thread

Instrument Air (III), DISS 2280	2002
WAGD (EVAC), DISS 2220	0202

Hex Nut and Nipple with 1/4" NPT Male



9/16"-18 Thread	
Oxygen, DISS 1240	1242-7
3/4"-16 Thread	
Carbon Dioxide, DISS 1080-A	0804
Medical Air, DISS 1160-A	1604
Nitrogen, DISS 1120-A	1204
Nitrous Oxide, DISS 1040-A	0404
Vacuum (Suction), DISS 1220	2204
7/8"-14 Thread	
Instrument Air (III), DISS 2280	2004
WAGD (EVAC), DISS 2220	0204

Hex Nut and Nipple with 1/4" I.D. Hose Barb



9/16"-18 Thread	
Oxygen, DISS 1240 (without O-ring)	1242-3
Oxygen, DISS 1240	1242-30
3/4"-16 Thread	
Carbon Dioxide, DISS 1080-A	0817
He-O2 Mixture (I), DISS 1060-A	0617
Medical Air, DISS 1160-A	1617
Nitrogen, DISS 1120-A	1217
Nitrous Oxide, DISS 1040-A	0417
O2-He Mixture (II), DISS 1180-A	1817
Vacuum (Suction), DISS 1220	2217
7/8"-14 Thread	
Instrument Air (III), DISS 2080	2017
WAGD (EVAC), DISS 2220	0217

Hex Nut and Nipple with 5/16" I.D. Hose Barb



AV CORPORATION

	3/4"-16 Thread	2231
Vacuum (Suction), DISS 1220		
	7/8"-14 Thread	0231
WAGD (EVAC), DISS 2220		













DISS Hand-Tight Nut & Nipple Combinations

200 psi max

Hand-Tight Nut and Nipple with 1/8" NPT Male





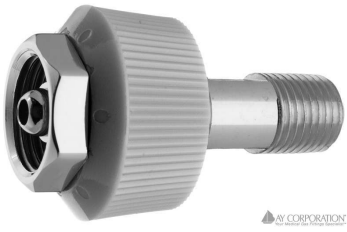

AV CORPORATION

	9/16"-18 Thread	
Oxygen, DISS 1240, with 1" nipple	 Green	2402HT
Oxygen, DISS 1240, with 1 1/2" nipple	 Green	1242-6HT
	3/4"-16 Thread	
Carbon Dioxide, DISS 1080-A	 Grey	0802HT
Medical Air, DISS 1160-A	 Yellow	1602HT
Nitrogen, DISS 1120-A	 Black	1202HT
Nitrous Oxide, DISS 1040-A	 Blue	0402HT
Vacuum (Suction), DISS 1220	 White	2202HT
	7/8"-14 Thread	
Instrument Air (I), DISS 2080	 Red	2002HT
WAGD (EVAC), DISS 2220	 Purple	0202HT
	ISO Color-coded	
Medical Air, DISS 1160-A	 Black & White	1602HTC
Vacuum (Suction), DISS 1220	 Yellow	2202HTC
Oxygen, DISS 1240, with 1" nipple	 White	2402HTC
Oxygen, DISS 1240, with 1 1/2" nipple	 White	1242-6HTC



Hand-Tight Nut and Nipple with 1/4" NPT Male





3/4"-16 Thread

Carbon Dioxide, DISS 1080-A	 Grey	0804HT
Medical Air, DISS 1160-A	 Yellow	1604HT
Nitrogen, DISS 1120-A	 Black	1204HT
Nitrous Oxide, DISS 1040-A	 Blue	0404HT
Vacuum (Suction), DISS 1220	 White	2204HT

7/8"-14 Thread

Instrument Air (I), DISS 2080	 Red	2004HT
WAGD (EVAC), DISS 2220	 Purple	0204HT

ISO Color-coded

Medical Air, DISS 1160-A	 Black & White	1604HTC
Vacuum (Suction), DISS 1220	 Yellow	2204HTC

Hand-Tight Nut and Nipple with 1/4" I.D. Hose Barb



9/16"-18 Thread

Oxygen, DISS 1240	 Green	2417HT
-------------------	--	---------------

3/4"-16 Thread

Carbon Dioxide, DISS 1080-A	 Grey	0817HT
-----------------------------	---	---------------

Medical Air, DISS 1160-A	 Yellow	1617HT
--------------------------	---	---------------

Nitrogen, DISS 1120-A	 Black	1217HT
-----------------------	--	---------------

Nitrous Oxide, DISS 1040-A	 Blue	0417HT
----------------------------	---	---------------

Vacuum (Suction), DISS 1220	 White	2217HT
-----------------------------	--	---------------

7/8"-14 Thread

Instrument Air (I), DISS 2080	 Red	2017HT
-------------------------------	--	---------------

WAGD (EVAC), DISS 2220	 Purple	0217HT
------------------------	---	---------------

ISO Color-coded

Medical Air, DISS 1160-A	 Black & White	1617HTC
--------------------------	---	----------------

Vacuum (Suction), DISS 1220	 Yellow	2217HTC
-----------------------------	---	----------------

Oxygen, DISS 1240	 White	2417HTC
-------------------	--	----------------

Hand-Tight Nut and Nipple with 5/16" I.D. Hose Barb



3/4"-16 Thread

Vacuum (Suction), DISS 1220	 White	2231HT
-----------------------------	--	---------------

7/8"-14 Thread

WAGD (EVAC), DISS 2220	 Purple	0231HT
------------------------	---	---------------

ISO Color-coded

Vacuum (Suction), DISS 1220	 Yellow	2231HTC
-----------------------------	---	----------------



1. Heliox mixtures: Helium over 80%.
2. Heliox mixtures: Helium not over 80%.
3. Intended for the powering of medical devices unrelated to human respiration.

Outlet Conversions

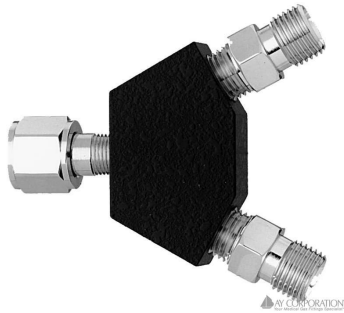
DISS Hex Nut Female Inlet, DISS Male Outlets



3/4"-16 Thread

Medical Air, DISS 1160-A	 Yellow	YO-116X
Nitrogen, DISS 1120-A	 Black	YO-112X
Nitrous Oxide, DISS 1040-A	 Blue	YO-104X
Vacuum (Suction), DISS 1220	 White	YO-122X

9/16"-18 Thread

Oxygen, DISS 1240	 Green	YO-124X
-------------------	--	-------------------------

DISS Hand-Tight Nut Female Inlet, DISS Male Outlets

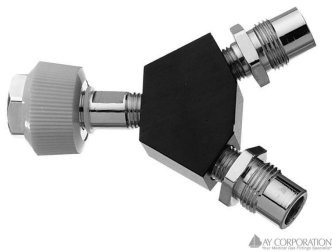

3/4"-16 Thread

Medical Air, DISS 1160-A	 Yellow	YO-116
Nitrogen, DISS 1120-A	 Black	YO-112
Nitrous Oxide, DISS 1040-A	 Blue	YO-104
Vacuum (Suction), DISS 1220	 White	YO-122





9/16"-18 Thread

Oxygen, DISS 1240	 Green	YO-124
-------------------	--	------------------------

DISS Hand-Tight Nut Female Inlet, DISS Demand Check Outlets



3/4"-16 Thread

Medical Air, DISS 1160-A	 Yellow	YO-116DV
Nitrogen, DISS 1120-A	 Black	YO-112DV
Nitrous Oxide, DISS 1040-A	 Blue	YO-104DV
Vacuum (Suction), DISS 1220	 White	YO-122DV
Carbon Dioxide, DISS 1080-A	 Grey	YO-108DV

9/16"-18 Thread

Oxygen, DISS 1240	 Green	YO-124DV
-------------------	--	--------------------------

Puritan®-Style Quick Connects

Bay Corporation manufactures the four most popular quick-connects on the market: Chemetron®-style, Ohmeda®-style, Puritan®-style, and Schrader®-style. Each version has been designed and engineered to be interchangeable with the original equipment manufacturer's design in function, quality, and appearance. By utilizing our quick-connects, you can expect unparalleled durability, high-flow and short-projection designs, clearly-marked gas identification, quick off-the-shelf delivery and competitive prices. Gas Services available: Medical Air, Nitrous Oxide, Oxygen, Vacuum and WAGD (EVAC).

Male Quick-Connects

1/8" NPT Male

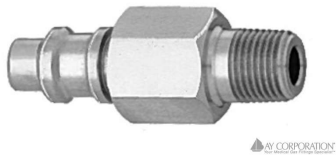

Medical Air	PQ-116-2
Nitrous Oxide	PQ-104-2
Oxygen	PQ-124-2
Vacuum (Suction)	PQ-122-2
WAGD (EVAC)	PQ-EVA-2

1/8" NPT Female

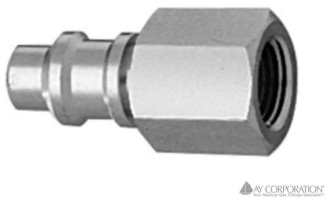

Medical Air	PQ-116-2F
Nitrous Oxide	PQ-104-2F
Oxygen	PQ-124-2F
Vacuum (Suction)	PQ-122-2F
WAGD (EVAC)	PQ-EVA-2F





1/4" NPT Male



Medical Air	PQ-116-4
Nitrous Oxide	PQ-104-4
Oxygen	PQ-124-4
Vacuum (Suction)	PQ-122-4
WAGD (EVAC)	PQ-EVA-4

DISS Male



Medical Air	 Yellow	PQ-116-9
Nitrous Oxide	 Blue	PQ-104-9
Oxygen	 Green	PQ-124-9
Vacuum (Suction)	 White	PQ-122-9
WAGD (EVAC)	 Purple	PQ-EVA-9

DISS Female Hex Nut & Nipple



Medical Air		PQ-116-16
Nitrous Oxide		PQ-104-04
Oxygen		PQ-124-24
Vacuum (Suction)		PQ-122-22
WAGD (EVAC)		PQ-EVA-22





1/4" I.D. Hose Barb



1/4" I.D. Hose Barb

Nitrous Oxide		PQ-104-17
Medical Air	ISO: PQ-116-17C	PQ-116-17
Vacuum (Suction)	ISO: PQ-122-17C	PQ-122-17
Oxygen	ISO: PQ-124-17C	PQ-124-17
WAGD (EVAC)		PQ-EVA-17

U.S. Color Coded

Medical Air	 Yellow	PQ-116-17
Nitrous Oxide	 Blue	PQ-104-17
Oxygen	 Green	PQ-124-17
Vacuum (Suction)	 White	PQ-122-17
WAGD (Evac)	 Purple	PQ-EVA-17

5/16" I.D. Hose Barb

Vacuum (Suction)	ISO: PQ-122-31C	PQ-122-31
WAGD (EVAC)		PQ-EVA-31



ISO Color Coded

Medical Air	 Black & White	PQ-116-17C
Oxygen	 White	PQ-124-17C
Vacuum (Suction)	 Yellow	PQ-122-17C

5/16" I.D. Hose Barb



U.S. Color Coded





Vacuum (Suction)	 White	PQ-122-31
WAGD (Evac)	 Purple	PQ-EVA-31

ISO Color Coded

Vacuum (Suction)	 Yellow	PQ-122-31C
------------------	---	-------------------





DISS Demand Check Unit



Medical Air	 Yellow	PQ-116-9DV
Nitrous Oxide	 Blue	PQ-104-9DV
Oxygen	 Green	PQ-124-9DV
Vacuum (Suction)	 White	PQ-122-9DV
WAGD (EVAC)	 Purple	PQ-EVA-PDV

DISS Female Hand Tight Nut & Nipple







Medical Air	 Yellow	PQ-116-HT
Nitrous Oxide	 Blue	PQ-104-HT
Oxygen	 Green	PQ-124-HT
Vacuum (Suction)	 White	PQ-122-HT
WAGD (EVAC)	 Purple	PQ-EVA-HT

Female Couplers and Dual Outlet Connections





1/4" NPT Male



Medical Air	 Yellow	PQF-16-4
Nitrous Oxide	 Blue	PQF-04-4
Oxygen	 Green	PQF-24-4
Vacuum (Suction)	 White	PQF-22-4
WAGD (EVAC)	 Purple	PQF-EV-4



1/4" I.D. Hose Barb



Medical Air	 Yellow	PQF-16-17
Nitrous Oxide	 Blue	PQF-04-17
Oxygen	 Green	PQF-24-17
Vacuum (Suction)	 White	PQF-22-17
WAGD (EVAC)	 Purple	PQF-EV-17

5/16" I.D. Hose Barb







Vacuum (Suction)	 White	PQF-22-31
WAGD (EVAC)	 Purple	PQF-EV-31

Dual Outlet Connections

200 PSI max

Male Quick-Connect Inlet, Female Coupler Outlets



Medical Air	 Yellow	YO-PQ16
Oxygen	 Green	YO-PQ24
Vacuum (Suction)	 White	YO-PQ22
WAGD (Evac)	 Purple	YO-PQEV

Schrader®-Style Quick Connects

Bay Corporation manufactures the four most popular quick-connects on the market: Chemetron®-style, Ohmeda®-style, Puritan®-style, and Schrader®-style. Each version has been designed and engineered to be interchangeable with the original equipment manufacturer's design in function, quality, and appearance. By utilizing our quick-connects, you can expect unparalleled durability, high-flow and short-projection designs, clearly-marked gas identification, quick off-the-shelf delivery and competitive prices. Gas Services available: Medical Air, Nitrous Oxide, Oxygen, Vacuum and WAGD (EVAC).

Non-Swivel Male Quick-Connects

1/8" NPT Male

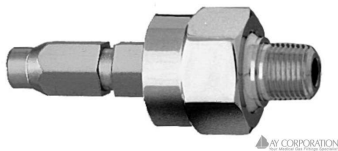

Medical Air	SCH-116-2
Nitrogen	SCH-112-2
Nitrous Oxide	SCH-104-2
Oxygen	SCH-124-2
Vacuum (Suction)	SCH-122-2

1/8" NPT Female

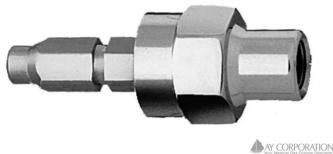

Medical Air	SCH-116-2F
Nitrogen	SCH-112-2F
Nitrous Oxide	SCH-104-2F
Oxygen	SCH-124-2F
Vacuum (Suction)	SCH-122-2F

1/4" I.D. Hose Barb

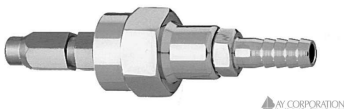

Medical Air	SCH-116-17
Nitrous Oxide	SCH-104-17
Nitrogen	SCH-112-17
Oxygen	SCH-124-17
Vacuum (Suction)	SCH-122-17

5/16" I.D. Hose Barb

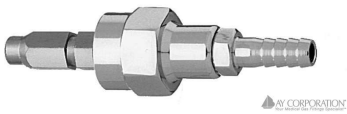

Vacuum (Suction)

[SCH-122-31](#)

DISS Male

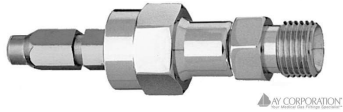

Medical Air

[SCH-116-9](#)

Nitrogen

[SCH-112-9](#)

Nitrous Oxide

[SCH-104-9](#)

Oxygen

[SCH-124-9](#)

Vacuum (Suction)

[SCH-122-9](#)

DISS Female Hex Nut & Nipple

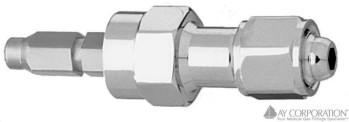

Medical Air

[SCH-116-16](#)

Nitrogen

[SCH-112-12](#)

Nitrous Oxide

[SCH-104-04](#)

Oxygen

[SCH-124-24](#)

Vacuum (Suction)

[SCH-122-22](#)

DISS Demand Check Unit

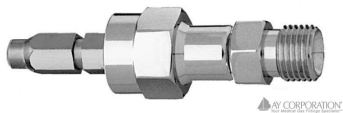

Medical Air

[SCH-116-9DV](#)

Nitrogen

[SCH-112-9DV](#)

Nitrous Oxide

[SCH-104-9DV](#)

Oxygen





[SCH-124-9DV](#)

Vacuum (Suction)

[SCH-122-9DV](#)

DISS Female Hand-Tight Nut & Nipple



Medical Air	 Yellow	SCH-116-HT
Nitrogen	 Black	SCH-112-HT
Nitrous Oxide	 Blue	SCH-104-HT
Oxygen	 Green	SCH-124-HT
Vacuum (Suction)	 White	SCH-122-HT

Swivel Style Male Quick-Connects

1/8" NPT Male

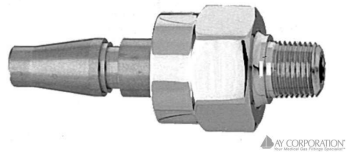

Medical Air		SH-16-2S
Nitrogen		SH-12-2S
Nitrous Oxide		SH-04-2S
Oxygen		SH-24-2S
Vacuum (Suction)		SH-22-2S

1/8" NPT Female

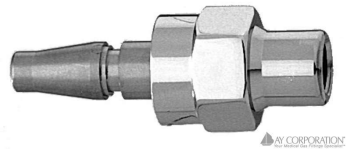

Medical Air		SH-16-2FS
Nitrogen		SH-12-2FS
Nitrous Oxide		SH-04-2FS
Oxygen		SH-24-2FS
Vacuum (Suction)		SH-22-2FS

1/4" I.D. Hose Barb

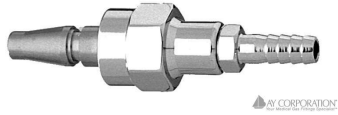

1/4" I.D. Hose Barb

Medical Air	SH-116-17S
Nitrogen	SH-112-17S
Nitrous Oxide	SH-104-17S
Oxygen	SH-124-17S
Vacuum (Suction)	SH-122-17S
Medical Air	SH-16-17S
Nitrogen	SH-12-17S
Nitrous Oxide	SH-04-17S
Oxygen	SH-24-17S
Vacuum (Suction)	SH-22-17S

5/16" I.D. Hose Barb

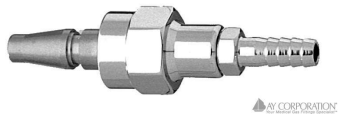

Vacuum (Suction)	SH-122-31S
------------------	----------------------------

DISS Male

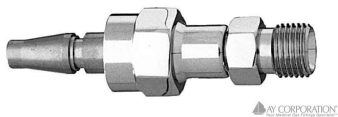

Medical Air	SH-16-9S
Nitrogen	SH-12-9S
Nitrous Oxide	SH-04-9S
Oxygen	SH-24-9S
Vacuum (Suction)	SH-22-9S

DISS Female Hex Nut & Nipple

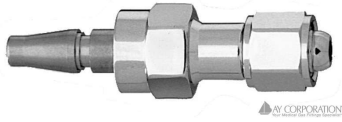

Medical Air	SH-16-16S
Nitrogen	SH-12-12S
Nitrous Oxide	SH-04-04S
Oxygen	SH-24-24S
Vacuum (Suction)	SH-22-22S



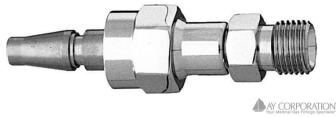

DISS Demand Check Unit

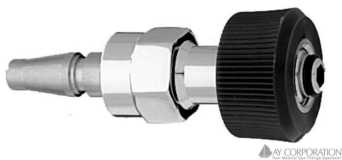

Medical Air	SH-16-9DVS
Nitrogen	SH-12-9DVS
Nitrous Oxide	SH-04-9DVS
Oxygen	SH-24-9DVS
Vacuum (Suction)	SH-22-9DVS

DISS Female Hand-Tight Nut & Nipple



Medical Air	 Yellow	SH-16-HTS
Nitrogen	 Black	SH-12-HTS
Nitrous Oxide	 Blue	SH-04-HTS
Oxygen	 Green	SH-24-HTS
Vacuum (Suction)	 White	SH-22-HTS

Female Couplers

1/4" NPT Male



Medical Air		SCF-16-4
Nitrous Oxide		SCF-04-4
Oxygen		SCF-24-4
Vacuum (Suction)		SCF-22-4
Medical Air		SCF-16-4
Nitrous Oxide		SCF-04-4
Oxygen		SCF-24-4
Vacuum (Suction)		SCF-22-4
	Black Cap	
Nitrogen		SCF-12-4
Medical Air		SCF-16-4

1/4" I.D. Hose Barb



Medical Air		SCF-16-17
Nitrous Oxide		SCF-04-17
Oxygen		SCF-24-17
Vacuum (Suction)		SCF-22-17
	Black Cap	
Nitrogen		SCF-12-17

5/16" I.D. Hose Barb



Vacuum (Suction)

SCF-12-31

Dual Outlet Connections

200 PSI max

Non-Swivel Male Quick-Connect Inlet, Female Coupler Outlets



Medical Air

YO-SC16

Nitrous Oxide

YO-SC04

Oxygen

YO-SC24

Vacuum (Suction)

YO-SC22

Black Cap

Nitrogen



Black

YO-SC12

Ohmeda®-Style Quick Connects

Bay Corporation manufactures the four most popular quick-connects on the market: Chemetron®-style, Ohmeda®-style, Puritan®-style, and Schrader®-style. Each version has been designed and engineered to be interchangeable with the original equipment manufacturer's design in function, quality, and appearance. By utilizing our quick-connects, you can expect unparalleled durability, high-flow and short-projection designs, clearly-marked gas identification, quick off-the-shelf delivery and competitive prices. Gas Services available: Carbon Dioxide, Medical Air, Nitrous Oxide, Oxygen, Vacuum and WAGD (EVAC).





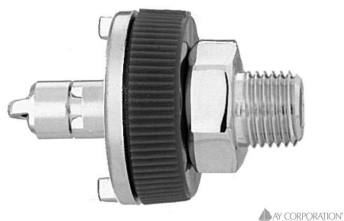

Male Quick-Connects

1/8" NPT Male



BAY CORPORATION

U.S. Color Coded

Carbon Dioxide	 Grey	OH-108-2
Medical Air	 Yellow	OH-116-2
Nitrous Oxide	 Blue	OH-104-2
Oxygen	 Green	OH-124-2
Vacuum (Suction)	 White	OH-122-2
WAGD (EVAC)	 Purple	OH-EVA-2



ISO Color Coded

Medical Air	 Black & White	OH-116-2C
Oxygen	 White	OH-124-2C
Vacuum (Suction)	 Yellow	OH-122-2C

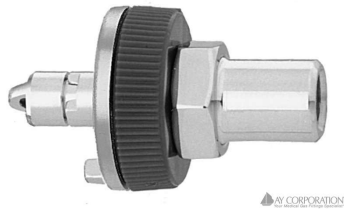

1/8" NPT Female



U.S. Color Coded







Carbon Dioxide	 Grey	OH-108-2F
Medical Air	 Yellow	OH-116-2F
Nitrous Oxide	 Blue	OH-104-2F
Oxygen	 Green	OH-124-2F
Vacuum (Suction)	 White	OH-122-2F
WAGD (EVAC)	 Purple	OH-EVA-2F

ISO Color Coded

Medical Air	 Black & White	OH-116-2FC
Oxygen	 White	OH-124-2FC
Vacuum (Suction)	 Yellow	OH-122-2FC

1/4" NPT Male



Carbon Dioxide	 Grey	OH-108-4
Medical Air	 Yellow	OH-116-4
Nitrous Oxide	 Blue	OH-104-4
Oxygen	 Green	OH-124-4
Vacuum (Suction)	 White	OH-122-4
WAGD (EVAC)	 Purple	OH-EVA-4

1/4" I.D. Hose Barb





AV CORPORATION

U.S. Color Coded

Carbon Dioxide	 Grey	OH-108-17
Medical Air	 Yellow	OH-116-17
Nitrous Oxide	 Blue	OH-104-17
Oxygen	 Green	OH-124-17
Vacuum (Suction)	 White	OH-122-17
WAGD (EVAC)	 Purple	OH-EVA-17

ISO Color Coded



Medical Air	 Black & White	OH-116-17C
Oxygen	 White	OH-124-17C
Vacuum (Suction)	 Yellow	OH-122-17C

5/16" I.D. Hose Barb



AV CORPORATION

U.S. Color Coded

Vacuum (Suction)	 White	OH-122-31
WAGD (Evac)	 Purple	OH-EVA-31





ISO Color Coded

Vacuum (Suction)	 Yellow	OH-122-31C
------------------	---	----------------------------

DISS Male









AV CORPORATION

Medical Air	 Yellow	OH-116-9
Nitrous Oxide	 Blue	OH-104-9
Oxygen	 Green	OH-124-9
Vacuum (Suction)	 White	OH-122-9
WAGD (EVAC)	 Purple	OH-EVA-9





DISS Female Hex Nut & Nipple

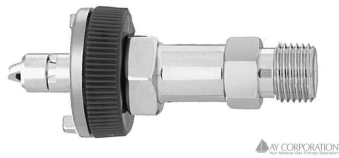

Carbon Dioxide	 Grey	OH-108-08
Medical Air	 Yellow	OH-116-16
Nitrous Oxide	 Blue	OH-104-04
Oxygen	 Green	OH-124-24
Vacuum (Suction)	 White	OH-122-22
WAGD (EVAC)	 Purple	OH-EVA-22





DISS Demand Check Unit



Medical Air	 Yellow	OH-116-9DV
Nitrous Oxide	 Blue	OH-104-9DV
Oxygen	 Green	OH-124-9DV
Vacuum (Suction)	 White	OH-122-9DV

DISS Female Hand Tight Nut & Nipple









Medical Air	 Yellow	OH-116-HT
Nitrous Oxide	 Blue	OH-104-HT
Oxygen	 Green	OH-124-HT
Vacuum (Suction)	 White	OH-122-HT
WAGD (EVAC)	 Purple	OH-EVA-HT

Female Couplers







1/8" NPT Male



Carbon Dioxide	 Grey	OHF-08-2
Medical Air	 Yellow	OHF-16-2
Nitrous Oxide	 Blue	OHF-04-2
Oxygen	 Green	OHF-24-2
Vacuum (Suction)	 White	OHF-22-2
WAGD (EVAC)	 Purple	OHF-EV-2







1/8" NPT Female



Carbon Dioxide	 Grey	OHF-08-2F
Medical Air	 Yellow	OHF-16-2F
Nitrous Oxide	 Blue	OHF-04-2F
Oxygen	 Green	OHF-24-2F
Vacuum (Suction)	 White	OHF-22-2F
WAGD (EVAC)	 Purple	OHF-EV-2F







1/4" NPT Male



Carbon Dioxide	 Grey	OHF-08-4
Medical Air	 Yellow	OHF-16-4
Nitrous Oxide	 Blue	OHF-04-4
Oxygen	 Green	OHF-24-4
Vacuum (Suction)	 White	OHF-22-4
WAGD (EVAC)	 Purple	OHF-EV-4



1/4" I.D. Hose Barb



Carbon Dioxide		OHF-08-17
Medical Air		OHF-16-17
Nitrous Oxide		OHF-04-17
Oxygen		OHF-24-17
Vacuum (Suction)		OHF-22-17
WAGD (EVAC)		OHF-EV-17





5/16" I.D. Hose Barb



Vacuum (Suction)		OHF-22-31
WAGD (Evac)		OHF-EV-31

DISS Male



Medical Air		OHF-16-9
Nitrous Oxide		OHF-04-9
Oxygen		OHF-24-9
Vacuum (Suction)		OHF-22-9



DISS Female Hex Nut & Nipple



Medical Air		OHF-16-16
Nitrous Oxide		OHF-04-04
Oxygen		OHF-24-24
Vacuum (Suction)		OHF-22-22

DISS Female Hand Tight Nut & Nipple



Medical Air	 Yellow	OHF-16-HT
Nitrous Oxide	 Blue	OHF-04-HT
Oxygen	 Green	OHF-24-HT
Vacuum (Suction)	 White	OHF-22-HT

Dual Outlet Connections





Male Quick-Connect Inlet, Female Coupler Outlets



Medical Air	 Yellow	YO-OH16
Nitrous Oxide	 Blue	YO-OH04
Oxygen	 Green	YO-OH24
Vacuum (Suction)	 White	YO-OH22



Male Quick-Connect Inlet-Centered, Female Coupler Outlets



Medical Air	 Yellow	YO-OHT16
Nitrous Oxide	 Blue	YO-OHT04
Oxygen	 Green	YO-OHT24
Vacuum (Suction)	 White	YO-OHT22





Male Quick-Connect Inlet-Right, Female Coupler Outlets



Medical Air	 Yellow	YO-OHR16
Nitrous Oxide	 Blue	YO-OHR04
Oxygen	 Green	YO-OHR24
Vacuum (Suction)	 White	YO-OHR22

Male Quick-Connect Inlet-Left, Female Coupler Outlets



Medical Air	 Yellow	YO-OHL16
Nitrous Oxide	 Blue	YO-OHL04
Oxygen	 Green	YO-OHL24
Vacuum (Suction)	 White	YO-OHL22

Chemetron®-Style Quick Connects





Bay Corporation manufactures the four most popular quick-connects on the market: Chemetron®-style, Ohmeda®-style, Puritan®-style, and Schrader®-style. Each version has been designed and engineered to be interchangeable with the original equipment manufacturer's design in function, quality, and appearance. By utilizing our quick-connects, you can expect unparalleled durability, high-flow and short-projection designs, clearly-marked gas identification, quick off-the-shelf delivery and competitive prices. Gas Services available: Medical Air, Nitrous Oxide, Oxygen, Vacuum and WAGD (EVAC).

Male Quick-Connects

1/8" NPT Male







BAY CORPORATION

Medical Air	 Yellow	CM-116-2
Nitrous Oxide	 Blue	CM-104-2
Oxygen	 Green	CM-124-2
Vacuum (Suction)	 White	CM-122-2
WAGD (EVAC)	 Purple	CM-EVA-2

1/8" NPT Female







BAY CORPORATION

Medical Air	 Yellow	CM-116-2F
Nitrous Oxide	 Blue	CM-104-2F
Oxygen	 Green	CM-124-2F
Vacuum (Suction)	 White	CM-122-2F
WAGD (EVAC)	 Purple	CM-EVA-2F





1/4" NPT Male

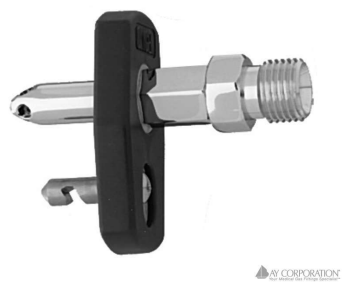

Medical Air	 Yellow	CM-116-4
Nitrous Oxide	 Blue	CM-104-4
Oxygen	 Green	CM-124-4
Vacuum (Suction)	 White	CM-122-4
WAGD (EVAC)	 Purple	CM-EVA-4





DISS Male



Medical Air	 Yellow	CM-116-9
Nitrous Oxide	 Blue	CM-104-9
Oxygen	 Green	CM-124-9
Vacuum (Suction)	 White	CM-122-9
WAGD (EVAC)	 Purple	CM-EVA-9

DISS Female Hex Nut & Nipple





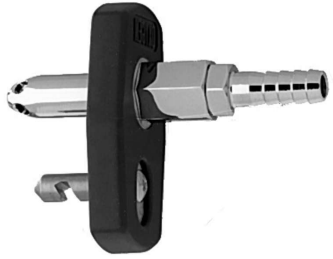

Medical Air	 Yellow	CM-116-16
Nitrous Oxide	 Blue	CM-104-04
Oxygen	 Green	CM-124-24
Vacuum (Suction)	 White	CM-122-22
WAGD (EVAC)	 Purple	CM-EVA-22

1/4" I.D. Hose Barb





AV CORPORATION

Medical Air	 Yellow	CM-116-17
Nitrous Oxide	 Blue	CM-104-17
Oxygen	 Green	CM-124-17
Vacuum (Suction)	 White	CM-122-17
WAGD (Evac)	 Purple	CM-EVA-17

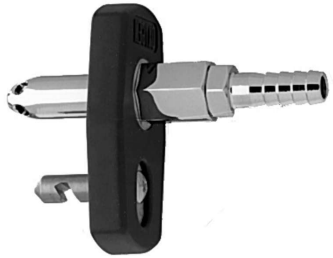
5/16" I.D. Hose Barb



AV CORPORATION

Vacuum (Suction)	 White	CM-122-31
WAGD (EVAC)	 Purple	CM-EVA-31

DISS Demand Check Unit

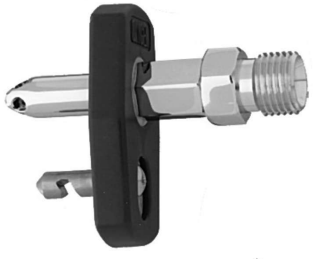





AV CORPORATION

Medical Air	 Yellow	CM-116-9DV
Nitrous Oxide	 Blue	CM-104-9DV
Oxygen	 Green	CM-124-9DV
Vacuum (Suction)	 White	CM-122-9DV

DISS Female Hand Tight Nut & Nipple



AV CORPORATION





Medical Air	 Yellow	CM-116-HT
Nitrous Oxide	 Blue	CM-104-HT
Oxygen	 Green	CM-124-HT
Vacuum (Suction)	 White	CM-122-HT
WAGD (EVAC)	 Purple	CM-EVA-HT

Female Couplers

1/8" NPT Male







AV CORPORATION
THE MEDICAL GAS TESTING EXPERTS

Medical Air	 Yellow	CMF-16-2
Nitrous Oxide	 Blue	CMF-04-2
Oxygen	 Green	CMF-24-2
Vacuum (Suction)	 White	CMF-22-2
WAGD (EVAC)	 Purple	CMF-EV-2

1/8" NPT Female







AV CORPORATION
THE MEDICAL GAS TESTING EXPERTS

Medical Air	 Yellow	CMF-16-2F
Nitrous Oxide	 Blue	CMF-04-2F
Oxygen	 Green	CMF-24-2F
Vacuum (Suction)	 White	CMF-22-2F
WAGD (EVAC)	 Purple	CMF-EV-2F

1/4" NPT Male







AV CORPORATION
THE MEDICAL GAS TESTING EXPERTS

Medical Air	 Yellow	CMF-16-4
Nitrous Oxide	 Blue	CMF-04-4
Oxygen	 Green	CMF-24-4
Vacuum (Suction)	 White	CMF-22-4
WAGD (EVAC)	 Purple	CMF-EV-4

1/4" I.D. Hose Barb





AV CORPORATION
AN AMERSON COMPANY

Medical Air	 Yellow	CMF-16-17
Nitrous Oxide	 Blue	CMF-04-17
Oxygen	 Green	CMF-24-17
Vacuum (Suction)	 White	CMF-22-17
WAGD (Evac)	 Purple	CMF-EV-17

5/16" I.D. Hose Barb



AV CORPORATION
AN AMERSON COMPANY

Vacuum (Suction)	 White	CMF-22-31
WAGD (EVAC)	 Purple	CMF-EV-31

DISS Male





AV CORPORATION
AN AMERSON COMPANY

Medical Air	 Yellow	CMF-16-9
Nitrous Oxide	 Blue	CMF-04-9
Oxygen	 Green	CMF-24-9
Vacuum (Suction)	 White	CMF-22-9

DISS Female Hex Nut & Nipple



Medical Air	 Yellow	CMF-16-16
Nitrous Oxide	 Blue	CMF-04-04
Oxygen	 Green	CMF-24-24
Vacuum (Suction)	 White	CMF-22-22

AV CORPORATION
ANALOGOUS TECHNOLOGIES

DISS Female Hand Tight Nut & Nipple





Medical Air	 Yellow	CMF-16-HT
Nitrous Oxide	 Blue	CMF-04-HT
Oxygen	 Green	CMF-24-HT
Vacuum (Suction)	 White	CMF-22-HT

AV CORPORATION
ANALOGOUS TECHNOLOGIES

Dual Outlet Connections

Male Quick-Connect Inlet, Female Coupler Outlets





Medical Air	 Yellow	YO-CM16
Nitrous Oxide	 Blue	YO-CM04
Oxygen	 Green	YO-CM24
Vacuum (Suction)	 White	YO-CM22

AV CORPORATION
ANALOGOUS TECHNOLOGIES

Male Quick-Connect Inlet-Centered, Female Coupler Outlets



Medical Air	 Yellow	YO-CMT16
Nitrous Oxide	 Blue	YO-CMT04
Oxygen	 Green	YO-CMT24
Vacuum (Suction)	 White	YO-CMT22

Male Quick-Connect Inlet-Right, Female Coupler Outlets

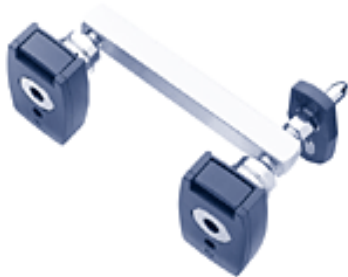

Medical Air	 Yellow	YO-CMR16
Nitrous Oxide	 Blue	YO-CMR04
Oxygen	 Green	YO-CMR24
Vacuum (Suction)	 White	YO-CMR22

Male Quick-Connect Inlet-Left, Female Coupler Outlets



Medical Air	 Yellow	YO-CML16
Nitrous Oxide	 Blue	YO-CML04
Oxygen	 Green	YO-CML24
Vacuum (Suction)	 White	YO-CML22

90° Swivel

Our innovative 90° swivel adaptor --- don't be fooled by its deceptively simple design; our one-of-a-kind 90° swivel adaptor is revolutionizing hose fittings in the medical field and beyond. Part of our complete line of pipe thread to barbed hose adaptors; the 90° swivel adaptor helps prevent dangerous kinks and chaffing that can result in leakage.

Stay on the cutting edge of technology with our patent-pending 90° swivel adaptor.

The innovative design provides increased mobility while maintaining a secure connection; and you can save money on replacements and enjoy the full life of your hoses when you decrease wear and tear at the point of contact between hoses and adaptors.

- Tamper resistant design
- Permits 360° rotation
- Avoid hose kinking
- Improve safety
- Compact

[Click here for a printable PDF copy with more information on the 90° Swivel Adaptor from Bay Corporation.](#)

[Click here to use our Hose Configurator](#)

Click below to go to the 90° Swivel catalog page.

90° Swivel

90° Swivel Adaptor



90° Swivel, 1/8" NPT Female x 1/4" I.D. Hose Barb

FPT-24-90S

90° Swivel, 1/8" NPT Female x 5/16" I.D. Hose Barb





FPT-25-90S

SIS (Australian)

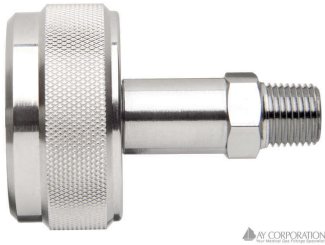
SIS Probes



1/8" NPT Male



Oxygen	 White	AS-2402
Breathing Air	 Black & White	AS-1602
Vacuum (Suction)	 Yellow	AS-2202
Nitrous Oxide	 Blue	AS-0402

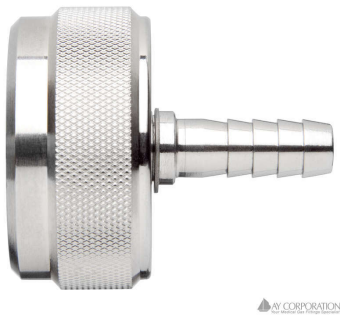



1/4" I.D. Hose Barb



Oxygen	 White	AS-2417
Breathing Air	 Black & White	AS-1617
Vacuum (Suction)	 Yellow	AS-2217
Nitrous Oxide	 Blue	AS-0417

1/4" I.D. Hose Barb, 90° Swivel







Oxygen	 White	AS-2417-90
Breathing Air	 Black & White	AS-1617-90
Vacuum (Suction)	 Yellow	AS-2217-90
Nitrous Oxide	 Blue	AS-0417-90

AFNOR (French)

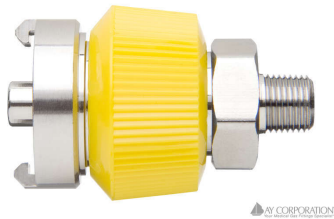
AFNOR Probes





1/8" NPT Male



Oxygen		AF-2402
Breathing Air		AF-1602
Vacuum (Suction)		AF-2202
Nitrous Oxide		AF-0402





1/4" I.D. Hose Barb



Oxygen		AF-2417
Breathing Air		AF-1617
Vacuum (Suction)		AF-2217
Nitrous Oxide		AF-0417

1/4" I.D. Hose Barb, 90° Swivel



Oxygen with 1/4" ID hose barb		AF-2417-90
Breathing Air		AF-1617-90
Vacuum (Suction)		AF-2217-90
Nitrous Oxide		AF-0417-90

DIN (German)

DIN Probes





1/8" NPT Male



Oxygen	DIN-2402
Breathing Air	DIN-1602
Vacuum (Suction)	DIN-2202
Nitrous Oxide	DIN-0402

1/4" I.D. Hose Barb with Grip



Oxygen	 White	DIN-2417
Breathing Air	 Black & White	DIN-1617
Vacuum (Suction)	 Yellow	DIN-2217
Nitrous Oxide	 Blue	DIN-0417

1/4" I.D. Hose Barb



Oxygen	DIN-2417-LG
Breathing Air	DIN-1617-LG
Vacuum (Suction)	DIN-2217-LG
Nitrous Oxide	DIN-0417-LG

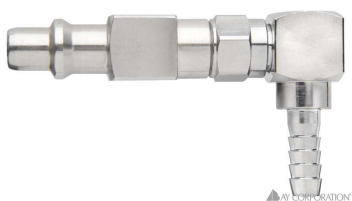

1/4" I.D. Hose Barb, 90° Swivel

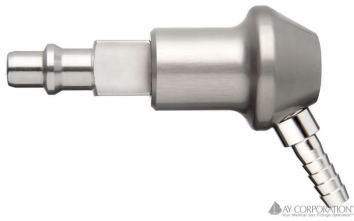

Oxygen	DIN-2417-90
Breathing Air	DIN-1617-90
Vacuum (Suction)	DIN-2217-90
Nitrous Oxide	DIN-0417-90

1/4" I.D. Hose Barb w/ Ergo-grip



Oxygen	 White	DIN-2417-AGL
Breathing Air	 Black & White	DIN-1617-AGL
Vacuum (Suction)	 Yellow	DIN-2217-AGL
Nitrous Oxide	 Blue	DIN-0417-AGL

BS (British)

BS Probes

1/8" NPT Male



Oxygen		BS-2402
Breathing Air		BS-1602
Vacuum (Suction)		BS-2217
Nitrous Oxide		BS-0417

1/4" I.D. Hose Barb w/ Grip



Oxygen		BS-2417
Breathing Air		BS-1617
Vacuum (Suction)		BS-2217
Nitrous Oxide		BS-0417

1/4" I.D. Hose Barb



Oxygen		BS-2417-LG
Breathing Air		BS-1617-LG
Vacuum (Suction)		BS-2217-LG
Nitrous Oxide		BS-0417-LG

1/4" I.D. Hose Barb, 90° Swivel





Oxygen		BS-2417-90
Breathing Air		BS-1617-90
Vacuum (Suction)		BS-2217-90
Nitrous Oxide		BS-0417-LG

BS Sockets

1/4" NPT Male



Medical Air (MA4)	 Black & White	BSF-16-4
Medical Vacuum	 Yellow	BSF-22-4
Nitrous Oxide	 Blue	BSF-04-4
Oxygen	 White	BSF-24-4

NIST (European)

NIST Probes

1/8" NPT Male

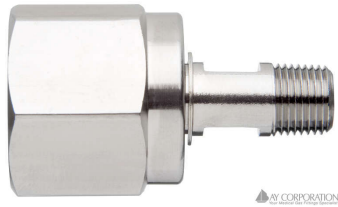

Oxygen	NIST-2402
Breathing Air	NIST-1602
Vacuum (Suction)	NIST-2202
Nitrous Oxide	NIST-0402

1/4" I.D. Hose Barb



Oxygen	NIST-2417
Breathing Air	NIST-1617
Vacuum (Suction)	NIST-2202
Nitrous Oxide	NIST-0417

NIST Sockets

1/8" NPT Male

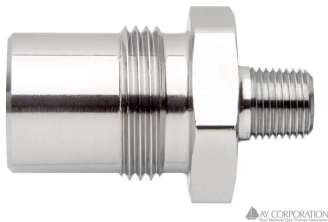

Oxygen	NIST-124-2
Breathing Air	NIST-116-2
Vacuum (Suction)	NIST-122-2
Nitrous Oxide	NIST-104-2

1/4" I.D. Hose Barb



Oxygen	NIST-124-17
Breathing Air	NIST-116-17
Vacuum (Suction)	NIST-122-17
Nitrous Oxide	NIST-104-17

1/4" NPT Male

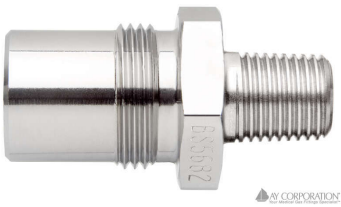

Oxygen	NIST-124-4
Breathing Air	NIST-116-4
Vacuum (Suction)	NIST-122-4
Nitrous Oxide	NIST-104-4

AGA (Scandinavian)

AGA Probes

1/8" NPT Male



Oxygen	SS-2402
Breathing Air	SS-1602
Vacuum (Suction)	SS-2202
Nitrous Oxide	SS-0402

1/4" I.D. Hose Barb



Oxygen	SS-2417-LG
Breathing Air	SS-1617-LG
Vacuum (Suction)	SS-2231-LG
Nitrous Oxide	SS-0417-LG

5/16" I.D. Hose Barb



Vacuum (Suction)	SS-2231-LG
------------------	------------

1/4" I.D. Hose Barb, 90° Swivel

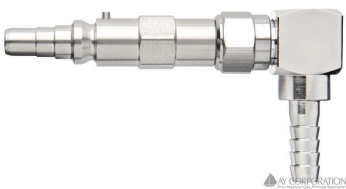

Oxygen	SS-2417-90
Breathing Air	SS-1617-90
Vacuum (Suction)	SS-2231-90
Nitrous Oxide	SS-0417-90

5/16" I.D. Hose Barb, 90° Swivel

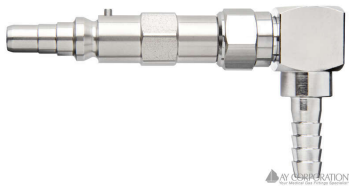

Vacuum (Suction)

SS-2231-90









Hose & Tubing

Conductive Hose (Color Coded)







1/4" Conductive Hose (.460" O.D.)



U.S. Color Coded

Carbon Dioxide	 Grey	2108-250
Instrument Air	 Red	2180-250
Medical Air	 Yellow	2116-250
Nitrogen	 Black	2112-250
Nitrous Oxide	 Blue	2104-250
Oxygen	 Green	2124-250
Vacuum (Suction)	 White	2122-250
WAGD (EVAC)	 Purple	2140-250



ISO Color Coded

Carbon Dioxide	 Grey	2108-250
Vacuum (Suction)	 Yellow	2116-250
Nitrogen	 Black	2112-250
Nitrous Oxide	 Blue	2104-250
Oxygen	 White	2122-250
WAGD (EVAC)	 Purple	2140-250
Medical Air	 Black & White	5116-250

5/16" Conductive Hose (.560" O.D.)



U.S. Color Coded

Vacuum (Suction)	 White	3122-250
WAGD (Evac)	 Purple	3140-250

Non-Conductive Hose (Color Coded)









- Non-Conductive Hose (Color Coded)
- Packaged in 250 foot reels (sold by foot)
- Inner core: Medical grade non-conductive PVC
- DEHP-Free
- Braid reinforced polyester
- Outer cover: Colored PVC - see charts
- Working pressure: 200 psi max. @ 70° F
- Working Temperature: 14° F to 150° F

1/4" Non-Conductive Hose (.460" O.D.)











BAY CORPORATION







U.S. Color Coded

General Purpose		Clear w/White Braid	BC-2225
Medical Air		Yellow	1416
Instrument Air		Red	1480
Nitrogen		Black	1458
Nitrous Oxide		Blue	1404
Oxygen		Green	1424
Vacuum (Suction)		White	1422
WAGD (Evac)		Purple	1440

1/4" I.D. (.460" O.D.)

General Purpose		Clear w/White Braid	BC-2225
Medical Air		Yellow	1416
Instrument Air		Red	1480
Nitrogen		Black	1458
Nitrous Oxide		Blue	1404
Oxygen		Green	1424
Vacuum (Suction)		White	1422
WAGD (EVAC)		Purple	1440

ISO Color Coded

General Purpose		Clear w/White Braid	BC-2225
Vacuum (Suction)		Yellow	1416
Nitrogen		Black	1458
Nitrous Oxide		Blue	1404
Oxygen		White	1422
WAGD (Evac)		Purple	1440

5/16" I.D. (.560" O.D.)

General Purpose		Clear w/White Braid	BC-2231
-----------------	---	---------------------	----------------

5/16" Non-Conductive Hose (.560" O.D.)



AV CORPORATION

General Purpose



Clear w/White Braid

BC-2231

Rubber Hose for Oxygen Service

Rubber Hose for Oxygen Service (.415" O.D.)

3.16" I.D. (.415" O.D.)

Oxygen



Green

3124

3.16" I.D.

Oxygen



Green

3124

Medical Grade Vinyl Tubing

Medical Grade Vinyl Tubing



AV CORPORATION

1/8" I.D. (1/4" O.D. - 1/16" Wall)

Maximum Working Pressure: 59 @ 70° F

HL-24

1/4" I.D. (3/8" O.D. - 1/16" Wall)

Maximum Working Pressure: 51 @ 70° F

HL-46

1/4" I.D. (7/16" O.D. - 3/32" Wall)

Maximum Working Pressure: 60 @ 70° F (I)

HL-47

Check Units & Valves

Compact Valves

NPT Male to NPT Male



AV CORPORATION
ANALYTICAL VALVE PRODUCTS

1/8" NPT Male Inlet, 1/8" NPT Male Outlet	7102
---	-------------

1/4" NPT Male Inlet, 1/4" NPT Male Outlet	7104
---	-------------

NPT Female to NPT Female



AV CORPORATION
ANALYTICAL VALVE PRODUCTS

1/8" NPT Female Inlet, 1/8" NPT Female Outlet	7202
---	-------------

1/4" NPT Female Inlet, 1/4" NPT Female Outlet	7204
---	-------------

NPT Male to NPT Female



AV CORPORATION
ANALYTICAL VALVE PRODUCTS

1/8" NPT Male Inlet, 1/8" Female Outlet	7302
---	-------------

1/4" NPT Male Inlet, 1/4" Female Outlet	7304
---	-------------

Demand Check Units

DV Body Adaptor, 1/8" NPT Male



9/16"-18 Thread

Oxygen, DISS 1240 **1241-2DV**

3/4"-16 Thread

He-O2 Mixture (I), DISS 1060-A **1061-2DV**

Medical Air, DISS 1160-A **1161-2DV**

Nitrogen, DISS 1120-A **1121-2DV**

Nitrous Oxide, DISS 1040-A **1041-2DV**

O2-He Mixture (II), DISS 1180-A **1181-2DV**

DV Body Adaptor, 1/4" NPT Male

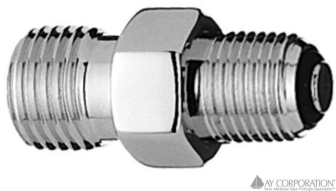

9/16"-18 Thread

Oxygen, DISS 1240 **1241-4DV**

3/4"-16 Thread

Carbon Dioxide, DISS 1080-A **1081-4DV**

He-O2 Mixture (I), DISS 1060-A **1061-4DV**

Medical Air, DISS 1160-A **1161-4DV**

Nitrogen, DISS 1120-A **1121-4DV**

Nitrous Oxide, DISS 1040-A **1041-4DV**

O2-He Mixture (II), DISS 1180-A **1181-4DV**

Vacuum (Suction), DISS 1220 **1221-4DV**

7/8"-14 Thread

Instrument Air, DISS 2080 **2081-4DV**

WAGD (EVAC), DISS 2220 **2221-4DV**





DV Body Adaptor, Barbed for 1/4" I.D. Hose with Hand Grip Collar





9/16"-18 Thread

Oxygen, DISS 1240	 Green	1241-17DV
-------------------	--	------------------

3/4"-16 Thread

Carbon Dioxide, DISS 1080-A	 Grey	1081-17DV
Medical Air, DISS 1160-A	 Yellow	1161-17DV
Nitrogen, DISS 1120-A	 Black	1121-17DV
Nitrous Oxide, DISS 1040-A	 Blue	1041-17DV
Vacuum (Suction), DISS 1220	 White	1221-17DV

7/8"-14 Thread

Instrument Air, DISS 2080	 Red	2081-17DV
WAGD (EVAC), DISS 2220	 Purple	2221-17DV

DV Body Adaptor, Barbed for 5/16" I.D. Hose with Hand Grip Collar



3/4"-16 Thread

Vacuum (Suction), DISS 1220		1221-31DV
-----------------------------	--	------------------

7/8"-14 Thread

WAGD (EVAC), DISS 2220		2221-31DV
------------------------	--	------------------

Extension Adaptors (III)



1/8" NPT Female x 1/8" NPT Male	AB-22
1/4" NPT Female x 1/4" NPT Male	AB-44

1. Heliox mixtures: Helium over 80%.
2. Heliox mixtures: Helium not over 80%.
3. Note: An extension adaptor is necessary when full-free extension of poppet is not obtained.

One-Way Check Valves

Body Adaptor, 1/8" NPT Male with One-Way Check

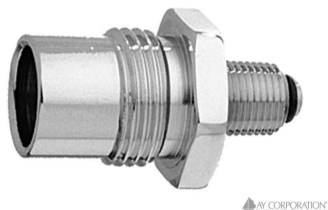

AV CORPORATION

9/16"-18 Thread

Oxygen, DISS 1240

1241-2CV

3/4"-16 Thread

Medical Air, DISS 1160-A

1161-2CV

Nitrous Oxide, DISS 1040-A

1041-2CV

Body Adaptor, 1/4" NPT Male with One-Way Check

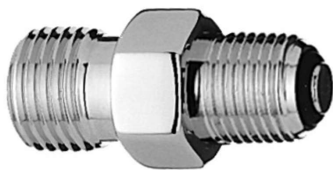

AV CORPORATION

9/16"-18 Thread

Oxygen, DISS 1240

1241-4CV

3/4"-16 Thread

Medical Air, DISS 1160-A

1161-4CV

Nitrous Oxide, DISS 1040-A

1121-4CV

Nitrogen, DISS 1120-A

1041-4CV

NPT Adaptors, with One-Way Check

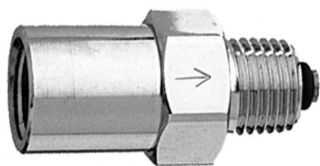

AV CORPORATION

Flows from 1/4" NPT Female to 1/4" NPT Male

AB-44CV

Flows from 1/4" NPT Male to 1/4" NPT Female

AB-44CVR

NPT Hex Nipple, with One-Way Check Valve



AV CORPORATION

1/4" NPT Male x 1/4" NPT Male

HN-4CV

Extension Adaptors (I)



1/8" NPT Female x 1/8" NPT Male

AB-22

1/4" NPT Female x 1/4" NPT Male

AB-44

Power Take-Off Assemblies

Compact Power Take-Off Assemblies

Compact Power Take-Off Assemblies



Oxygen, DISS 1240

[P-24](#)

Medical Air, DISS 1160-A

[P-16](#)

Extended Power Take-Off Assemblies

Extended Power Take-Off Assemblies



Oxygen, DISS 1240

[PTO-124](#)

Medical Air, DISS 1160-A

[PTO-116](#)

Power adaptor Block Less Fittings

Power adaptor Block Less Fittings



Extended Version, 3" long

[PTO-1](#)

Compact Version, 1.22" long

[ST-2](#)

Accessories & Tools

PTFE Thread Seal

High Density Teflon Tape



AV CORPORATION

For use with 1/8" NPT & 1/4" NPT Threads

1/4" x 520"	TFE-40
-------------	---------------

For use with 1/8" NPT & 1/4" NP

1/4" x 520"	TFE-40
-------------	---------------

For use with 1/2" NPT Threads &

1/2" x 520"	TFE-50
-------------	---------------

For use with 1/2" NPT Threads & Larger

1/2" x 520"	TFE-50
-------------	---------------

Components & Tools for Hose Assemblies

Ferrules



AV CORPORATION

9/16" Length

.450" I.D. (III)	Y-769
------------------	--------------

5/8" Length

.500" I.D. (I)	Y-624A
----------------	---------------

.525" I.D.	Y-625A
------------	---------------

31/64" Length

.548" I.D.	Y-626
------------	--------------

.575" I.D. (II)	Y-KK
-----------------	-------------

Bench Model Crimping Tool & Dies

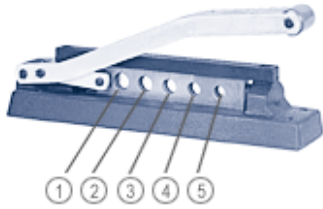

Crimping Tool, Bore diameters: (1) .630;
(2) .580; (3) .530 (III); (4) .480; (5) .437 (I)

CR-100

Heavy Duty Crimping Tool & Dies



AY CORPORATION
Your Medical Gas Fittings Specialist™

Crimping Tool

5111A

Recommended Die Set for Bay Corporation's
1/4" I.D. Hose

DR-39

Recommended Die Set for Bay Corporation's
5/16" I.D. Hose

DR-36

Recommended Die Set for Bay Corporation's
3/16" I.D. Hose

DR-41

Hose Retractor



Hose Retractor

1400-HR

Hose Cutting Device & Replacement Blade



BAY CORPORATION

Hose Cutter

HC-1

Replacement Blade

HC-1B

1. Recommended for Bay Corporation's 1/4" I.D. hose in conjunction with Bay Corporation's products.
2. Recommended for Bay Corporation's 5/16" I.D. hose in conjunction with Bay Corporation's products.
3. Recommended for Bay Corporation's 3/16" I.D. hose in conjunction with Bay Corporation's products.

Dual Outlet Y-Blocks

Dual Outlet Y Connections

Y-Blocks



AY CORPORATION
Your Medical Gas Fitting Specialist

1/8" NPT Female All Ports	YO-222
1/8" NPT Female Inlet X 1/4" Female Outlets	YO-244
1/4" NPT Female All Ports	YO-444

Extension Adaptor Blocks

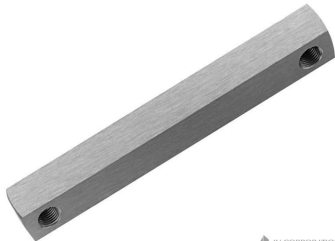

AY CORPORATION
Your Medical Gas Fitting Specialist

Centered Rear Inlet (I)	AA-11014
Offset Rear Inlet (I)	AA-11015

Filter Assemblies

Helps prevent moisture and water from entering downstream equipment while filtering out foreign material and debris. Designed for a service pressure of 150 psi maximum.

- Miniature Size
- 5 Micron Filter
- Manual Drain Valve
- High Flow Capacity

Straight Configurations

Straight Configurations



Medical Air, DISS 1060-A - Male Inlet x Female Outlet

AFA-116

Oxygen, DISS 1240 - Male Inlet x Female Outlet

AFA-124

90° Configurations

90° Configurations



Medical Air, DISS 1160-A - 90° Male Inlet x Female Outlet

A FA-116-90

Double 90° Configurations

Double 90° Configurations



Medical Air, DISS 1160-A - 90° Male Inlet x 90° Female Outlet

A FA-116-2-9

Filter Assemblies Less Fittings

Filter Assemblies Less Fittings



1/8" NPT Female Inlet x 1/8" NPT Female Outlet

AFA-2

Replacement Components for Filter Assemblies

Reservoirs



Reservoir with Manual Drain

AFA-10R



Filters



Filter Element, 5 Micron

AFA-5R



Pipe Thread Fittings

Pipe Thread to Barbed Hose Adaptors

Male NPT to Hose Barb



1/8" I.D. Hose Barb

1/8" NPT Male	MPT-22
1/4" NPT Male	MPT-42

3/16" I.D. Hose Barb

1/8" NPT Male	MPT-23
1/4" NPT Male	MPT-43

1/4" I.D. Hose Barb

1/8" NPT Male	MPT-24
1/4" NPT Male	MPT-44

5/16" I.D. Hose Barb

1/8" NPT Male	MPT-25
1/4" NPT Male	MPT-45

1/8" NPT Male to 'Bubble' Hose Barb (I)

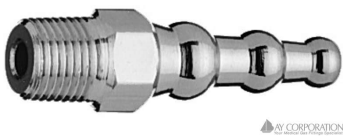

Bubble Barbed for 1/4"-3/8" Nominal I.D. Hose	BLN-2-17
Bubble Barbed for 3/8"-1/2" Nominal I.D. Hose	BLN-3-17

Female NPT to Hose Barb

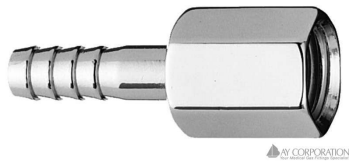

1/8" I.D. Hose Barb

1/8" NPT Female	FPT-22
1/4" NPT Female	FPT-42

3/16" I.D. Hose Barb

1/8" NPT Female	FPT-23
1/4" NPT Female	FPT-43

1/4" I.D. Hose Barb

1/8" NPT Female	FPT-24
1/4" NPT Female	FPT-44

5/16" I.D. Hose Barb

1/4" NPT Female	FPT-45
-----------------	---------------

90° Male NPT Barbed for 1/4" I.D. Hose



1/8" Male NPT	HA-217
Male 1/4" NPT	HA-417

Hose Splicers

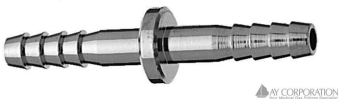

Barbed for Joining 1/8" I.D. Hose	HS-22
Barbed for Joining 3/16" I.D. Hose	HS-33
Barbed for Joining 1/4" I.D. Hose	HS-44

90° Female NPT to Hose Barb



1/8" NPT Female x 1/4" I.D. Barb	FPT-24-90
1/8" NPT Female x 5/16" I.D. Barb	FPT-25-90

90° Swivel Adaptor to Hose Barb (II)



AY CORPORATION
Your Medical Gas Fitting Specialist

1/8" NPT Female x 1/4" I.D. Hose Barb	FPT-24-90S
1/8" NPT Female x 5/16" I.D. Hose Barb	FPT-25-90S

Pipe Thread Fittings

Female to Male Adaptors



AY CORPORATION
Your Medical Gas Fitting Specialist

1/8" NPT Female X 1/8" NPT Male	AB-22
1/8" NPT Female X 1/4" NPT Male	AB-24
1/4" NPT Female X 1/8" NPT Male	AB-42
1/4" NPT Female X 1/4" NPT Male	AB-44

Branch Tees



AY CORPORATION
Your Medical Gas Fitting Specialist

1/8" NPT All Ports	BT-2
1/4" NPT All Ports	BT-4

Street Tees



1/8" NPT All Ports

ST-2

1/4" NPT All Ports

ST-4

AV CORPORATION

Crosses



1/8" NPT All Ports

CR-2

1/4" NPT All Ports

CR-4

AV CORPORATION

3-Way Tees

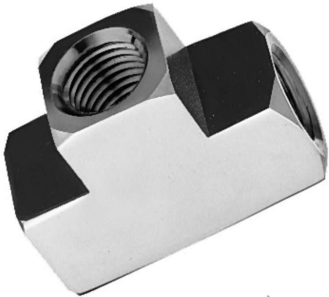

1/8" NPT All Ports

T-2

1/4" NPT All Ports

T-4

AV CORPORATION

90° Elbows



1/8" NPT All Ports

EL-2

1/4" NPT All Ports

EL-4

AV CORPORATION

90° Street Elbows



AV CORPORATION

1/8" NPT Female X 1/8" NPT Male	EL-22M
1/4" NPT Female X 1/8" NPT Male	EL-42M
1/4" NPT Female X 1/4" NPT Male	EL-44M

45° Elbows

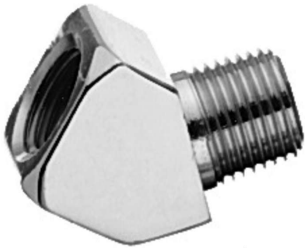

AV CORPORATION

1/8" NPT Female X 1/8" NPT Male	EL-2M45
1/4" NPT Female X 1/4" NPT Male	EL-4M45

Female to Female Couplers

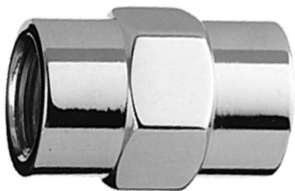

AV CORPORATION

1/8" NPT Female	FC-2
1/4" NPT Female	FC-4
1/4" NPT Female X 1/8" NPT Female	FC-42

Male to Male Hex Nipples



AV CORPORATION

1/8" NPT Male	HN-2
1/4" NPT Male	HN-4
1/4" NPT Male X 1/8" NPT Male	HN-42

Extension Adaptors



AV CORPORATION

Length - 2 1/2"

1/8" NPT Female X 1/8" NPT Male	LAB-22-25
---------------------------------	------------------

1/8" NPT Long Nipples



1 1/2" Length	LN-2-15
2" Length	LN-2-20
2 1/2" Length	LN-2-25

1/4" NPT Long Nipples



1 1/2" Length	LN-4-15
2" Length	LN-4-20
2 1/2" Length	LN-4-25
3" Length	LN-4-30
3 1/2" Length	LN-4-35

Hex Head Pipe Plugs

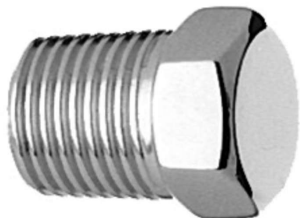

1/8" NPT Male	PG-2
1/4" NPT Male	PG-4

Countersunk Pipe Plugs



1/8" NPT Male	PG-2C
1/4" NPT Male	PG-4C

Bulkhead Assembly

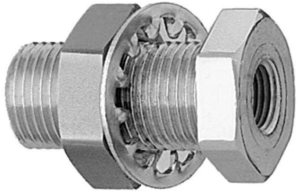

AV CORPORATION

1/8" NPT Female

BH-2

High Pressure Fittings

Flexible Pigtails

3000 PSI Max

Flexible Stainless Steel Pigtails, 1/4" NPT Female x 1/4" NPT Female



AV CORPORATION

18" Long	FP-4-18
24" Long	FP-4-24
36" Long	FP-4-36
48" Long	FP-4-48

Flexible Stainless Steel Pigtails, Gas Specific



AV CORPORATION

18" Length (less fittings)

Carbon Dioxide	FP-320-18
Medical Air	FP-346-18
Nitrogen	FP-580-18
Nitrous Oxide	FP-326-18

24" Length (less fittings)

Carbon Dioxide	FP-320-24
Medical Air	FP-346-24
Nitrogen	FP-580-24
Nitrous Oxide	FP-326-24

36" Length (less fittings)

Carbon Dioxide	FP-320-36
Medical Air	FP-346-36
Nitrogen	FP-580-36
Nitrous Oxide	FP-326-36

48" Length (less fittings)

Carbon Dioxide	FP-320-48
Medical Air	FP-346-48
Nitrogen	FP-580-48
Nitrous Oxide	FP-326-48

Insufflator Pigtail for Carbon Dioxide Service



AV CORPORATION

1/4" SAE Flare with 7/16"-20 Thread, Length - 36"	FP-123
---	---------------

Pigtails with Inlet Check Value, Gas Specific

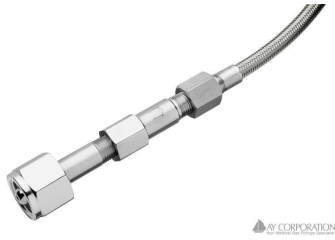

AV CORPORATION

18" Length (less fittings)

Carbon Dioxide	FP-320-18CV
Medical Air	FP-346-18CV
Nitrogen	FP-580-18CV
Nitrous Oxide	FP-326-18CV

24" Length (less fittings)

Carbon Dioxide	FP-320-24CV
Medical Air	FP-346-24CV
Nitrogen	FP-580-24CV
Nitrous Oxide	FP-326-24CV

36" Length (less fittings)

Carbon Dioxide	FP-320-36CV
Medical Air	FP-346-36CV
Nitrogen	FP-580-36CV
Nitrous Oxide	FP-326-36CV

48" Length (less fittings)

Carbon Dioxide	FP-320-48CV
Medical Air	FP-346-48CV
Nitrogen	FP-580-48CV
Nitrous Oxide	FP-326-48CV

Copper Pigtail for Manifolding Cylinders



AV CORPORATION

Oxygen, 20" fixed length; Unplated	BP-540-20
------------------------------------	---------------------------

One-Way Check Valve, 1/4" NPT Female Inlet x 1/4 NPT Male Outlet



AV CORPORATION

Adaptor with Nitrile O-ring	HP-44CV
Adaptor with Viton O-ring, for Oxygen service	HP-44CV-V

CGA Series Cylinder Valve Connections

3000 PSI Max

Medical Breathing Mixtures; CGA 280



AV CORPORATION

.750-14 NGO, RH-INT Thread

Hex Nut	284
Nipple, 2 1/2" x 1/4" NPT Male	285
Nipple w/filter, 2 1/2" x 1/4" NPT Male	285F

Carbon Dioxide; CGA 320



AV CORPORATION

.830-14 NGO, RH-INT Thread

Hex Nut	324
Nipple, 2 1/2" x 1/4" NPT Male	320-5
Nipple w/filter, 2 1/2" x 1/4" NPT Male	320-5F
Teflon washer for 320-5 & 320-5F nipples	360W

Nitrous Oxide; CGA 326



AV CORPORATION

.830-14 NGO, RH-INT Thread

Hex Nut	3264
Nipple, 2 1/2" x 1/4" NPT Male	3265
Nipple w/filter, 2 1/2" x 1/4" NPT Male	3265F

Medical Air, CGA 346

.830-14 NGO, RH-INT Thread



Hex Nut	344
Nipple, 2 1/2" x 1/4" NPT Male	345
Nipple w/filter, 2 1/2" x 1/4" NPT Male	345F

Medical Mixtures; CGA 500

.880-14 NGO, RH-INT Thread

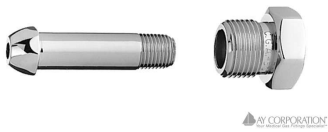

Hex Nut	504
Nipple, 2 1/2" x 1/4" NPT Male	503
Nipple w/filter, 2 1/2" x 1/4" NPT Male	503F

Oxygen; CGA 540

.908-14 NGO, RH-INT Thread



Hex Nut	544
Nipple, 2" x 1/4" NPT Male	543
Nipple w/filter, 2" x 1/4" NPT Male	543F
Nipple, 2 1/2" x 1/4" NPT Male	545
Nipple w/filter, 2 1/2" x 1/4" NPT Male	545F
Nipple, 3" x 1/4" NPT Male	547
Nipple w/filter, 3" x 1/4" NPT Male	547F

Oxygen, Hand-Tight; CGA 540

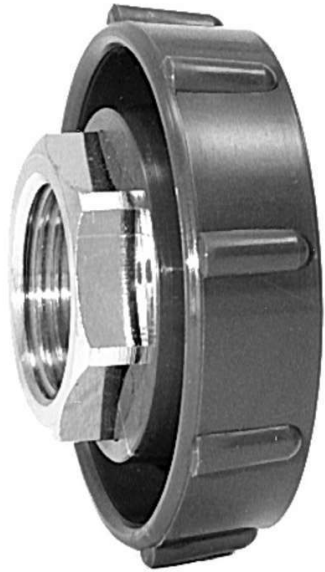

AY CORPORATION
Your Medical Gas Fittings Specialist

.908-14 NGO, RH-INT Thread

Hand-Tight Nut	 Green	544HT
Nipple w/Kel-F Tip 2 1/2" x 1/4" NPT Male		543HT
PCTFE replacement tip for 543HT Nipple		540-RT

Nitrogen, Helium; CGA 580



AY CORPORATION
Your Medical Gas Fittings Specialist

.960-14 NGO, RH-EXT Thread

Hex Nut		584
Nipple, 2 1/2" x 1/4" NPT Male		583
Nipple w/filter, 2 1/2" x 1/4" NPT Male		583F
Nipple, 3" x 1/4" NPT Male		585
Nipple w/filter, 3" x 1/4" NPT Male		585F

Cylinder Wrenches

Heavy Duty Metal Wrench



AY CORPORATION
Your Medical Gas Fittings Specialist

For Large Cylinder (1 1/8" Nut) and Medical D & E Cylinder Applications	WR-3
---	-------------

Polycarbonate Cylinder Wrenches



AY CORPORATION
Your Medical Gas Fitting Specialist™

Standard Wrench	WR-1
Standard Wrench, w/ 4" Loop Chain	WR-1C
Polycarbonate Wrench, with 6" Chain & Clip	WR-1CR
Polycarbonate Wrench, with 12" Chain & Clip	WR-1C12
Metal Wrench	WR-4

Pin-Indexed Yoke Assemblies

CGA 870



AY CORPORATION
Your Medical Gas Fitting Specialist™

Oxygen

CGA 540 Male	8701
1/4" NPT Male	8704
1/4" NPT Male w/ One-Way Check Valve and Rubber Washer	8704CV

CGA 880



AY CORPORATION
Your Medical Gas Filling Specialist

Carbon Dioxide & Oxygen Mixture

1/4" NPT Male

8804

Carbon Dioxide & Oxygen Mixtures (I)

1/4" NPT Male

8804

CGA 890



AY CORPORATION
Your Medical Gas Filling Specialist

Helium & Oxygen Mixtures (V)

1/4" NPT Male

8904

Nitrogen & Oxygen Mixtures (III)

1/4" NPT Male

8904

Xenon & Oxygen Mixtures (IV)

1/4" NPT Male

8904

CGA 910



AY CORPORATION
Four Medical Gas Fittings Specialist

Nitrous Oxide

CGA 326 Male	9101
1/4" NPT Male	9104
1/4" NPT Male w/One-Way Check Valve and Rubber Washer	9104CV

CGA 930



AY CORPORATION
Four Medical Gas Fittings Specialist

Helium

1/4" NPT Male	9304
---------------	------

Helium & Oxygen Mixtures (II)

1/4" NPT Male	9304
---------------	------

CGA 940



AY CORPORATION
Your Medical Gas Filling Specialist

Carbon Dioxide

1/4" NPT Male	9404
1/4" NPT Male w/ One-Way Check Valve & Rubber Washer	9404CV
Insufflator Yoke, 7/16" Flare	9406

Carbon Dioxide & Oxygen Mixtures (VI)

1/4" NPT Male	9404
1/4" NPT Male w/ One-Way Check Valve & Rubber Washer	9404CV
Insufflator Yoke, 7/16" Flare	9406

CGA 950



AY CORPORATION
Your Medical Gas Filling Specialist

Air

CGA 346 Male	9501
1/4" NPT Male	9504
1/4" NPT Male w/ One-Way Check Valve & Rubber Washer	9504CV

CGA 960



Nitrogen

CGA 580 Male

9601

1/4" NPT Male

9604

CGA 973 (VII)



Special Medical Mixtures

1/4" NPT Male

9734

Replacement Components for Yoke Assemblies



T-Bar Handle, Screw Length - 1 1/2"	TH-1
Extended T-Bar Handle, Screw Length - 2 3/16"	TH-2
Nitrile Washer with Aluminum Ring	RW-1
Fluorocarbon Washer with Brass Ring, recommended for Oxygen service	RW-2
Plastic Yoke Washer	TW-200